

GIZZU

HERO PRO 2048Wh UPS POWER STATION



GPS2000U USER MANUAL

Thank you for purchasing this Gizzu product.
Before operating this product, please ensure that you read the user manual carefully in order to make sure that the best possible performance is obtained.

FEATURES

- 2400W Power Output**
- Lithium Iron Phosphate (LiFePO4) Battery Technology**
- 2048Wh Battery Capacity**
- LED Flashlight**
- Supports Solar Charging (Solar Panels Sold Separately)**
- Ideal Solution For Power Outages**
- UPS Functionality With 10ms Switchover**
- Fully Charged Within 2 Hours**
- Portable Power Solution**
- Pure Sine Wave**

-1-

PACKAGE CONTENTS

1x Gizzu Hero Pro 2048Wh UPS Power Station
1x AC Charging Cable
1x Cigarette lighter to Anderson Plug cable
1x User Manual

SPECIFICATION

Model	GPS2000U	
Charging	Charging Input	Charging Time
	AC Input	220-240V/50Hz 1100W Max (2hrs)
	Anderson Input	11.5V-50V/25A 500W Max (4.8hrs)
Internal Battery Type	Lithium Iron Phosphate (LiFePO4)	
Battery Capacity	2048Wh	
Inverter	Pure Sine Wave	
LED Torch	1W/4000k	
AC Output	2x 220-240V/50Hz 2400W Rated	
DC Outputs	3x Type-C 20W PD Ports (5V-3A, 9V-2.22A, 12V/1.67A)	
	1x Type-C 100W PD Port (5V/9V/12V/15V-3A, 20V/5A)	
	2x USB-A 18W QC3.0 Ports	
	1x Car Socket Port (12V/10A)	
	2x DC5521 Ports (12V/3A)	
1x XT60 Port (12V/25A)		
Battery Management System	Yes	
UPS Mode (Switchover Time)	10ms	
Lifespan	3500 cycles	
Protection Features	Short-Circuit & Over-Current Protection	
	Over-Voltage & Under-Voltage Protection	
	Over-Load & Temperature Protection	
Dimensions	39.2x27.9x32.3cm	
Weight	22.5kg	
Warranty	2 Years	

Please note: The total power consumption for all connected appliances must be less than 2400W. If the power requirement draw exceeds 2400W, the wattage overdraw protection will provide up to 10 seconds of runtime before the unit shuts itself down. Wattage draw exceeding 4800W peak will cause the device to immediately shutdown and this may cause damage.

-2-

PRODUCT OVERVIEW

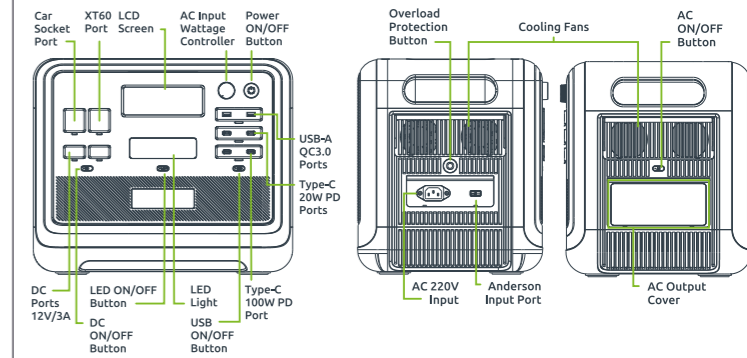

LCD DISPLAY SCREEN

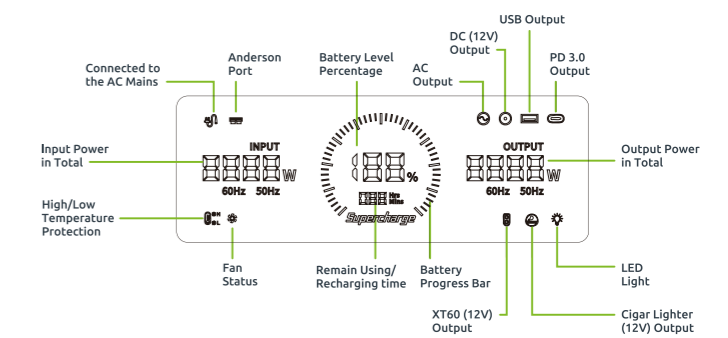

-3-

INTRODUCTION

Deliver power wherever and whenever you need it with the portable Gizzu Hero Pro UPS Power Station. The Hero Pro offers 2048Wh of battery capacity. It's great for keeping your devices charged during outdoor adventures and powering most household appliances during loadshedding. The elegant design is durable, robust, and can be taken with you on any adventure.

The Gizzu Hero Pro UPS Power Station features two 220V AC plugs, two USB ports, four Type-C ports, two DC ports, a car socket port, and an XT60 port. These ensure that you can charge or power multiple devices simultaneously. Pure Sine Wave technology and the ability to function like a UPS ensures that the Gizzu Hero Pro seamlessly switches over to battery power during loadshedding or a power outage, resulting in zero downtime for your connected essential devices.

The Hero Pro UPS Power Station is compatible with most large household appliances and power tools such as hairdryers, air fryers, coffee machines, washing machines, and electric drills.

The Gizzu Hero Pro UPS Power Station features Lithium Iron Phosphate (LiFePO4) batteries that recharge from 0% to 100% within 2 hours and has a rated lifespan of 3500 cycles. You can recharge the Hero Pro in multiple ways - recharge from your car, solar panel, or from traditional wall sockets at the home or office.

A battery management system helps to proactively monitor and manage the rechargeable battery. In addition, the Hero Pro also features safety features like short-circuit, over-current, over-voltage, under-voltage, over-load, and temperature protection.

Please note:

The total power consumption for all connected appliances must be less than 2400W. If the power requirement draw exceeds 2400W, the wattage overdraw protection will provide up to 10 seconds of runtime before the unit shuts itself down. Wattage draw exceeding 4800W peak will cause the device to immediately shutdown and this may cause damage.

-4-

ATTENTION

Do not attempt to use the equipment before you are familiar with the instructions. Keep these instructions for future use.

Attention should be paid, in particular, to safety guidelines. Please adhere to the technical requirements of AC devices you are about to attach to your Gizzu Hero Pro UPS Power Station. Failure to adhere to these requirements, or incorrect useage thereof, may cause personal injury or harm to others, as well as potentially resulting in damage to equipment.

Observe in particular the safety instructions given on the labels that are affixed to the device. Do not remove or damage these labels. This device must not be used by children.

Other uses or alterations to the device or use other than the intended purpose will immediately void the warranty and will pose a potentially serious health risk. The manufacturer is not liable for damages caused by any use other than the intended purpose.

USAGE AND HANDLING GUIDELINES

- For maximum performance, be sure to charge the power station if it has been unused and in storage for more than 3 months.
- Keep this device away from heat sources and direct sunlight whilst in use as well as when in storage.
- Do not use this product beyond the rated load.
- Be sure to use this product in a well-ventilated environment.
- Do not attempt to open the device. Opening the device may lead to risk of electric shock and fire.

GENERAL SAFETY INSTRUCTIONS

- Please use with caution when using this product near children.
- Do not put fingers, or any part of your body into the product.
- Do not operate the portable power station with a damaged cord, plug, or output cable as it could cause a short circuit or a risk of fire.

-5-

- Do not disassemble the portable power station as this may result in fire or electric shock.
- In the unlikely event of product failure, disconnect the portable power station from the power supply before performing any instructive maintenance operations.
- Please charge the product in a well-ventilated place, do not obstruct the air circulation.
- Please do not expose the product to fire or excessive heat.

WARNINGS

- Do not use as a toy
- Do not wet the machine
- Do not immerse the device in water
- Please only use original Gizzu accessories or make sure they comply with the correct specification requirements.
- Do not exceed the rated load of the product when used

DISCLAIMER

The manufacturer will not be held responsible for damages caused by:

- Incorrect connection and/or use.
- Impact of external forces, dropping the unit, or damaging parts of the device by mechanical impact or load.
- Any change made to the device.
- Using the device for purposes other than those described in this manual.
- Humidity and/or insufficient ventilation.
- Unauthorized opening of the device.

NOTE: The above mentioned will immediately void the warranty of the product.

-6-

STATEMENT OF LIMITED WARRANTY

This warranty covers a product that proves defective because of improper material or workmanship during the warranty period. Exclusions include problems caused by environmental conditions, malfunctions or damage due to negligence or mishandling of the equipment. For warranty claims and repair, please contact your local authorized reseller/service center.

GUIDE TO OPERATE

- Main Power Control**
 - Press and hold the power button for 3s to turn on/off the system
- LED Light Control**
 - Press the LED button to switch on the light, and again to change modes. Press and hold the button to switch the LED light off.

- USB Button**
 - Press the button to turn the USB ports on and off.

USB-A x 2	TYPE-C x 3	TYPE-C x 1
QC 3.0	PD-20W	PD-100W

- DC Button**
 - Press the button to turn the DC output ports on and off.

DC output x 2	Cigarette port x 1	XT60 x 1
12V/3A	12V/10A	12V/25A

-7-

5. LCD Display

- Shows the battery and power information.

6. AC Input Wattage Controller

- Use this dial to adjust the input power and rate of charge. Clockwise rotation increases the input power, and counterclockwise rotation decreases the input power. It is worth noting that charging this product at low power is beneficial for extending battery life.

7. Cooling Fans

- When the product reaches its temperature threshold set by the system, the cooling fan will automatically switch on, please note that fan noise below 60dB is normal. Do not block the cooling fans.

8. AC Button

- Press the button to turn the AC output ports on and off.

9. Anderson Port

- This interface supports charging from a solar panel input or car charger. For details, please refer to the 'Solar Panel Connection' and 'Car Charging' section

10. AC Input

- This device supports 1100W Fast charging and can fully recharge from 0 to 100% in 2hrs. When charging please pay attention to the following points:
 - Please connect directly to the wall socket to charge the product, do not recharge via an extension cord.
 - Please do not connect other electrical appliances to this socket as it may trip the DB board.

11. Overload Protection Button

- In the event of a power surge, the overload protection function (safety circuit breaker) will activate and cut off the AC input port.
- Please follow the sequence below to restore the AC input function:
 - Turn off the power button and unplug all connected appliances.
 - Turn on the power button.
 - Press the overload protection button, reconnect the AC Cable.

-8-

UPS MODE

UPS Feature

- This product has a bypass mode, power is supplied directly to appliances from the AC input, and seamlessly switches over in 10ms to battery in the event that AC power fails.

UPS Connections

- As shown in the figure below, connect the Power Station between the wall socket and the electrical appliances, ensure that the AC button is ON. When you turn on the power of the electrical appliances, it will use the AC power directly from the grid.
- If the grid power fails, it will automatically switch to the power station's internal battery to supply power.
- In UPS mode, the maximum power output must be less than 2400W. If the AC output exceeds 2400W the AC output icon "blinks" indicating overload and the battery will deplete.

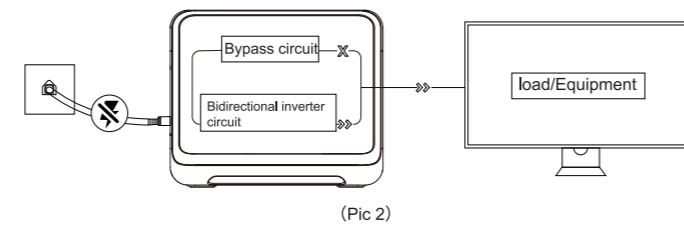
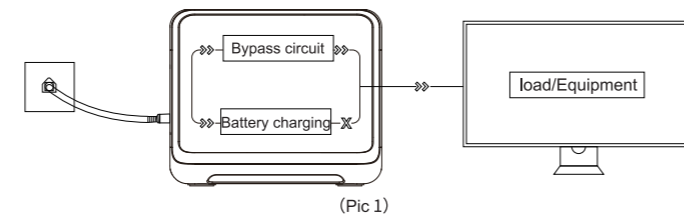

-9-

Solar Panel Connection

- This product can be recharged via solar panels. The charging time may vary according to weather conditions.
- This device supports a maximum input of 500W and an input voltage between 11.5-50V and a maximum of 25amps.
- Exceeding the maximum voltage can lead to equipment damage, and void the warranty.

We recommend the following two charging schemes:

Scheme 1 - Single panel connection

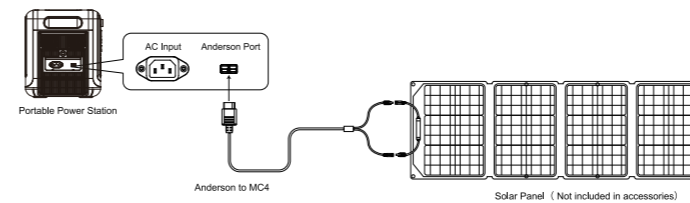

Scheme 2 - Multiple panel connection

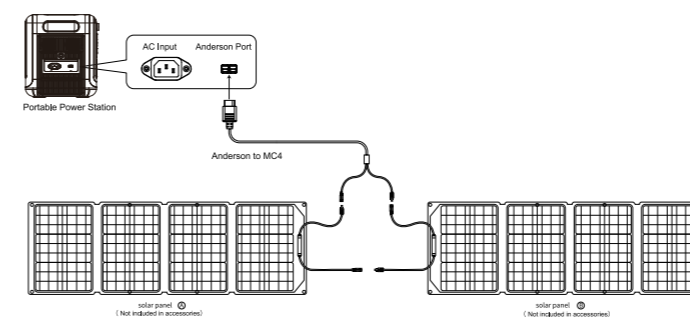

-10-

Car Charging

Recharge this power station from a car using the included car charging cable (see image below).

- This product supports 12V/24V car charger charging, please only recharge while the car is running, or the car battery may be exhausted.

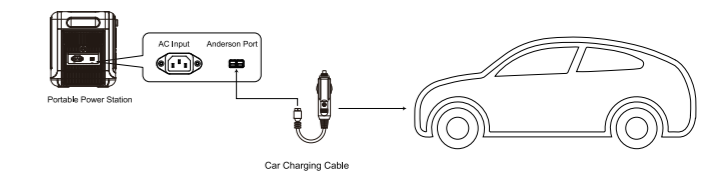

BATTERY SPECIFICATIONS

Battery Type	40135 LiFePo4
Single cell rated voltage	3.2V
Single cell rated capacity	20Ah
Battery pack rated voltage	51.2V
Battery pack output voltage	43.2-57.6V
Battery pack rated capacity	2048Wh

TROUBLESHOOTING TABLE

Phenomenon	Cause	Solution
The above output icon flashes and beeps.	The output exceeds the standard and it's short-circuited.	Remove the load, and then press the ON/OFF button of the corresponding output to remove the alarm
The temperature warning icon flashes and beeps.	The temperature of the product is too high or too low.	Stop charging the device and disconnect all appliances, turn the power off, wait for the device to reach a suitable working temperature, then the alarm is removed.
The icon of connecting to the AC mains flashes and the product cannot be charged.	The charging cable is poorly connected.	Securely connect the original AC Charging cable

-11-

FAQs

1. Can I take this product on an airplane?

No, because this product has a battery and according to the International Air Transportation standards and regulations, products that carry a battery cannot exceed a 100Wh battery capacity.

2. How do I store the product when it's not in use?

The portable power station needs to be stored in a dry environment. Always charge the device before storage and recharge every 6 months.

3. How do I clean the product if it is dirty?

Please use a dry non-abrasive cloth to wipe. Do not wipe directly with a wet cloth or chemical solvent. Do not expose the product to large amounts of water.

4. How do I properly care for this Lithium Iron Phosphate battery product?

Ensure that you keep the product clean, ensure that venting slots are clear of dust/obstructions, and ensure that the product can cool itself effectively. Periodic cleaning should be carried out without any liquids or compressed air.

5. Should I use a Universal Voltage Protector with this product?

We recommend the use of a Universal Voltage Protector when charging your Lithium Iron Phosphate battery product via AC input.

6. I accidentally dropped or damaged this product. Is it safe to continue using?

No, do not use a Lithium Iron Phosphate battery product if it has been dropped, shows visible signs of damage/bulging, or emits irregular noises.

7. Can I use any multi-plug or adapters with this product?

Please ensure that all connected devices, charging adapters, cables, and extension strips are properly certified for intended use, as well as compatible, with your Lithium Iron Phosphate battery product. The use of 3rd party, inexpensive power cords and extension strips can result in damage to connected devices or to your Lithium Iron Phosphate battery products.

-12-